

Inserts K80 pour crochets ramasseurs

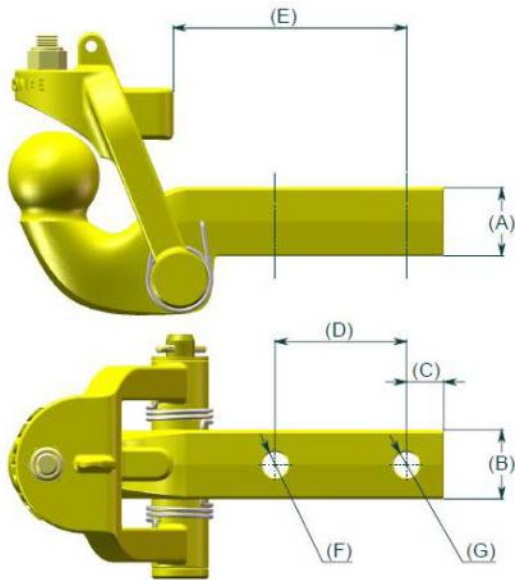

Référence	Description	Dimensions (mm)						
		A	B	C	D	E	F	G
D750-00280-00	Dromone PUH 60x60 - 2 trous	60	60	32.5	114.3	203	22.5	22.5
D750-00281-00	Dromone PUH 70x80 - 1 trou	70	80	43	----	203	----	30.5
D750-00317-00	Bennett 70x70 1 trou	70	70	108	----	138	----	30.5
D750-00328-00	Bennett 80x70 2 trous	80	70	38	115	253	26.5	26.5
D750-00342-00	Bennett 90x90 1 trou	90	90	43	----	203	----	30.5
D750-00324-00	NH/Case Swingback	70	70	50	153	305	22.5	22.5
D750-00318-00	JCB 60x60 Long Shank	60	60	48	----	378	----	30.5
D750-00329-00	CBM 60x60 2 trous	60	60	39.3	133	222	25.2	25.2
D750-00329-02	CBM 60x60 1 trou	60	60	39.3	----	222	----	25.2
D750-00340-00	CBM 70x70 1 trou	70	70	29.5	----	218	----	30.5



HB sarl
6, rue Baptiste Larpenteur
77810 Thomery
T. : 01.64.70.51.41
F. : 01.64.70.51.42
E. : contact@hb.fr
W : <http://www.h-b.fr>

Inserts K80 pour crochets ramasseurs

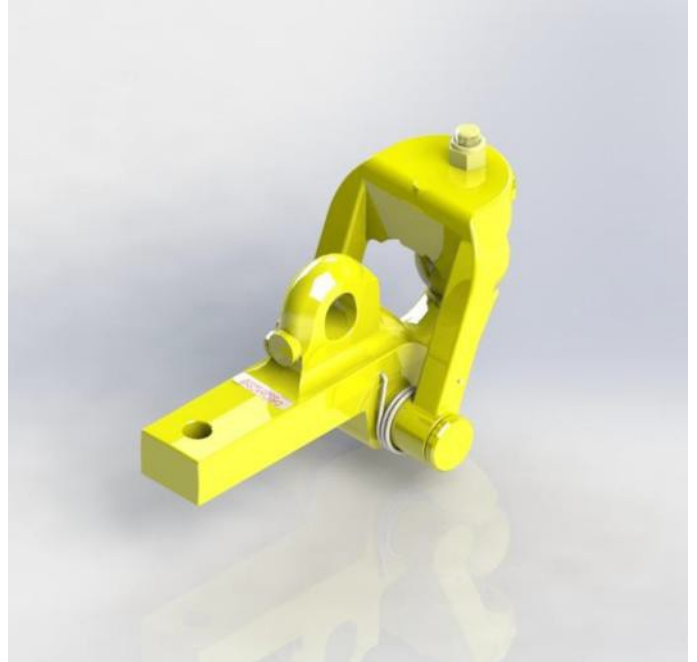
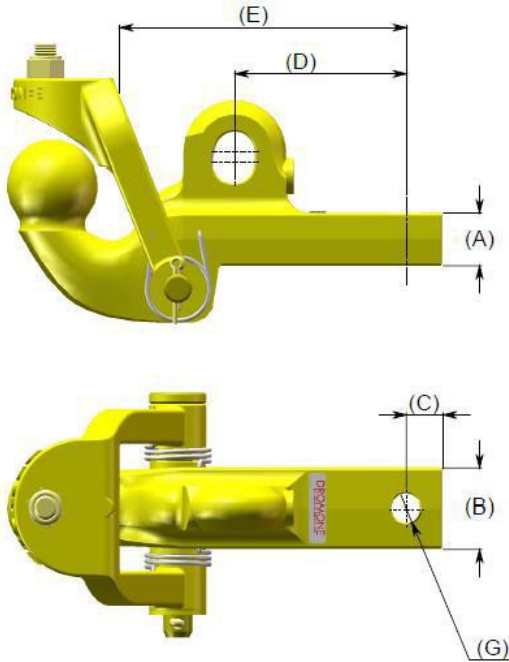

Référence	Description	Dimensions (mm)						
		A	B	C	D	E	F	G
D750-00282-00	JD 46x70 Forged Ball system	46	70	32	150	251	----	25.2
D750-00282-50	JD Latch ring c/w Steering Bracket	46	70	32	150	251	----	25.2
D750-00461-00	JD 7R Ball	60	70	32	150	276	----	25.2



HB sarl
6, rue Baptiste Larpenteur
77810 Thomery
T. : 01.64.70.51.41
F. : 01.64.70.51.42
E. : contact@hb.fr
W : <http://www.h-b.fr>

Inserts K80 pour crochets ramasseurs

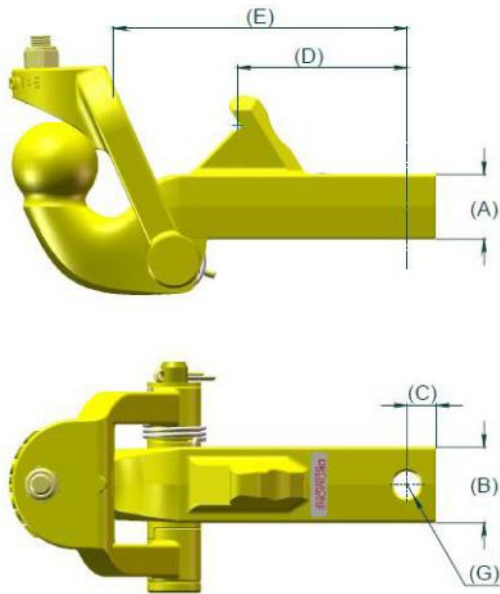





Référence	Description	Dimensions (mm)						
		A	B	C	D	E	F	G
D750-00283-00	NH/Case Pushback	60	70	27	156	266	----	25.2



HB sarl
6, rue Baptiste Larpenteur
77810 Thomery
T. : 01.64.70.51.41
F. : 01.64.70.51.42
E. : contact@hb.fr
W : <http://www.h-b.fr>

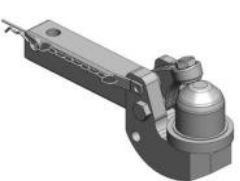

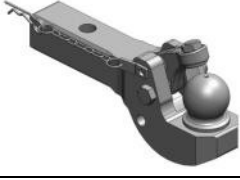
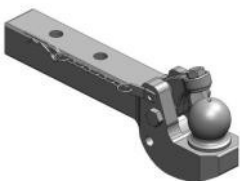
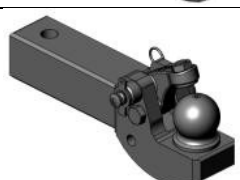

Inserts K80 pour crochets ramasseurs

Référence	Adaptation	Dimensions (mm)					Compatible crochet	
		Longueur totale	Longueur K80 / 1 ^{er} trou	Entre axe	Diamètre trous	Hauteur Largeur		
S00.421.10.2	Claas : Arès-Arion Fendt : Vario John Deere : 7010 Massey Ferguson : 5600 Dyna 4 & 6 6445-6480 7600 Dyna 6	415	210	114	22	60x60	Dromone	
S00.421.11.2	Claas Arion 610-640	415	210	114	29	60x60	Dromone	
S00.421.12.2	Case : 7100/7200 Magnum Deutz : Agrotron Agrotron TTV McCormick : MTX Same : Silver Zetor : Forterra Proxima	445	355	---	25	60x60	CBM	
S00.421.13.0	JCB : 2000 - 3000	590	495	---	30	60x60	Dromone	
S00.422.03.2	Fendt : Favorit- Vario 700/900 Vario 200-900 Vario SCR 500-900	435	282	---	30	70x70	Bennet	
S00.422.05.2	Fendt : Farmer 300-312 Favorit 800 Vario 200-900	545	282	115	26	70x80	Bennet	
S00.422.10.2	Fendt : Vario 200-900 Vario SCR 500-900	450	350	---	30	90x90	Bennet	

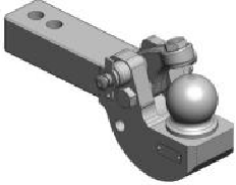
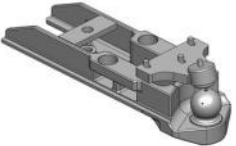

HB sarl
6, rue Baptiste Larpenteur
77810 Thomery
T. : 01.64.70.51.41
F. : 01.64.70.51.42
E. : contact@hb.fr
W : <http://www.h-b.fr>

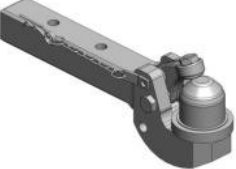



Inserts K80 pour crochets ramasseurs

Référence	Adaptation	Dimensions (mm)					Compatible crochet	
		Longueur totale	Longueur K80 / 1 ^{er} trou	Entre axe	Diamètre trous	Hauteur Largeur		
S00.422.60.0	Valtra : Série C Série M Série N Série T Série XM	417	336	---	26	60X80	LH-Lift	
S00.423.00.0		680	---	---	---	90X206	Scharmüller	
S00.425.00.3	John Deere : 6020 7020 7030	354	285	360x50	25	45x70	Sauermann	
S00.425.00.4	John Deere 6R 6170-6210	354	285	---	25	45x70	Sauermann	
S00.426.00.3	Fendt Favorit-Vario 700-900 Vario 200-900	545	265	125	22	70x70	Sauermann	
S00.426.11.1	Case : MXM New Holland :TM	528	295	153	23	70x70	Sauermann	
S00.426.12.1	Case : Magnum MX Fendt : Vario 200-900 McCormick : TTX	445	355	---	30	70x70	CBM	

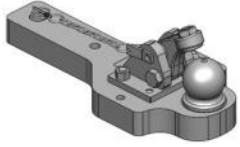

HB sarl
6, rue Baptiste Larpenteur
77810 Thomery
T. : 01.64.70.51.41
F. : 01.64.70.51.42
E. : contact@hb.fr
W : <http://www.h-b.fr>

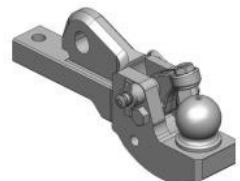
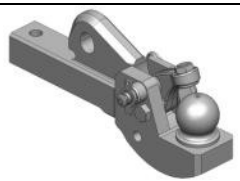
Inserts K80 pour crochets ramasseurs

Référence	Adaptation	Dimensions (mm)					Compatible crochet	
		Longueur totale	Longueur K80 / 1 ^{er} trou	Entre axe	Diamètre trous	Hauteur Largeur		
S00.426.20.2	Zetor: Forterra Proxima Super	722	357	280	22	65x65	Zetor	
S00.427.01.0		530	---	150	---	50x238	Scharmüller	
S00.427.10.0	Case : Farmall U- Pro Eff. Power Steyr : Multi	363	---	150	32	60x90	Scharmüller	
S00.428.00.5	John Deere : 6010-6020-6030 6R 7020-7030 8010-8020-8030	469	390	---	25	45x70	Sauermann	
S00.428.10.0	John Deere 7R	500	417	---	25	60x70	Sauermann	
S00.429.00.2	Claas Axion Fendt Vario 200-900 John Deere : 8030 - 8R Massey Ferguson 6485-6499 Tier2-3 7465-7499 7600 Dyna 6 8200 et 8400 McCormick : MTX Valtra : Série S	445	360	---	30	70x80	Dromone	
S00.429.10.0	JCB : 7000 - 8000	550	320	98	30.5	70x80	Domone	



HB sarl
6, rue Baptiste Larpenteur
77810 Thomery
T. : 01.64.70.51.41
F. : 01.64.70.51.42
E. : contact@hb.fr
W : <http://www.h-b.fr>