

Une gamme complète d'attelages à votre disposition en 325 ou 330 mm de large

ECHELLES

Standard

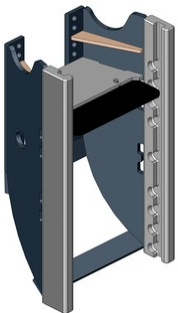

Courte

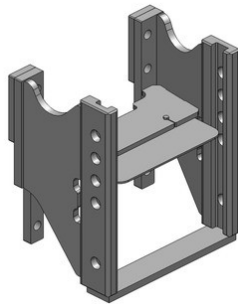

Piton fixe

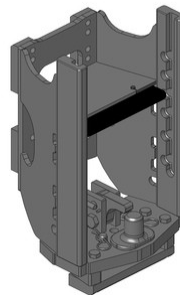

K 80

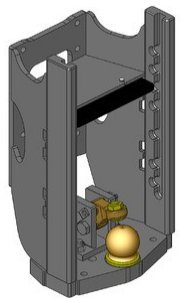

INSERTS

Piton fixe

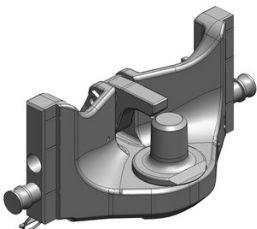

K 80

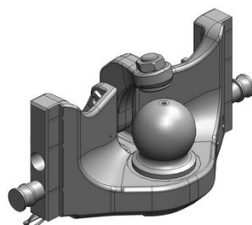

Chape tournante

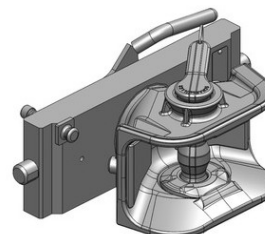

Chape automatique

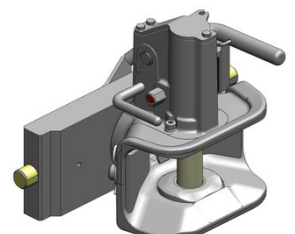

CROCHETS RAMASSEURS

Mécanique



Hydraulique

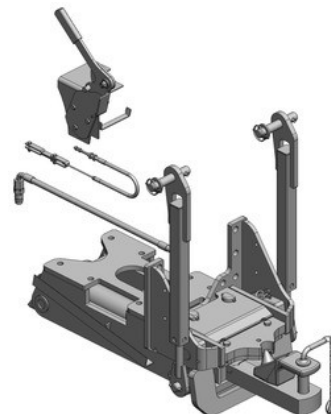

Besoin de renseignements, contactez-nous !